

WDE1200

WD

Baris 03

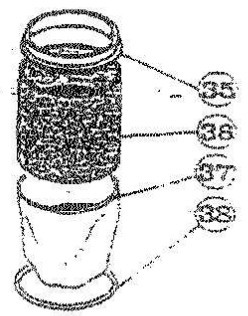
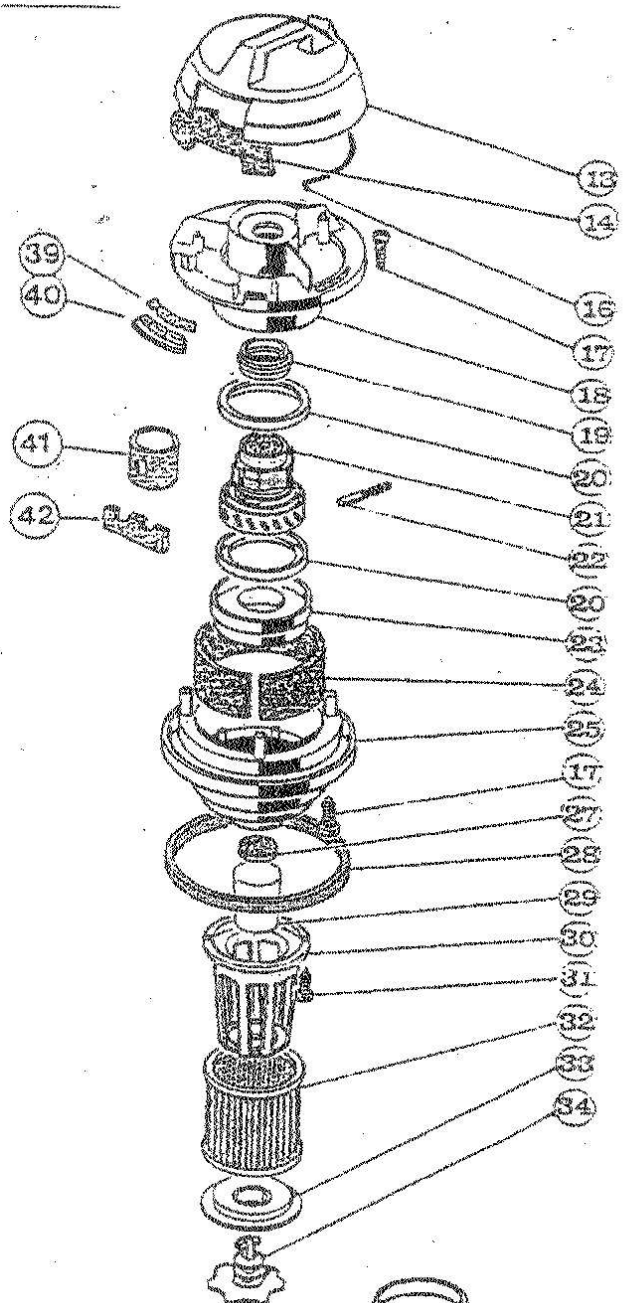
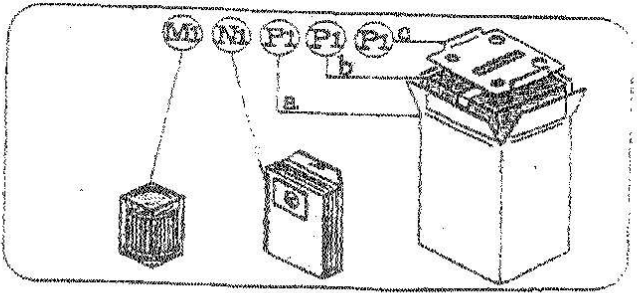
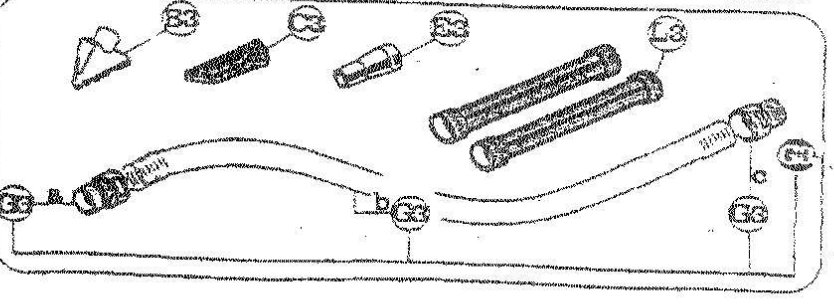
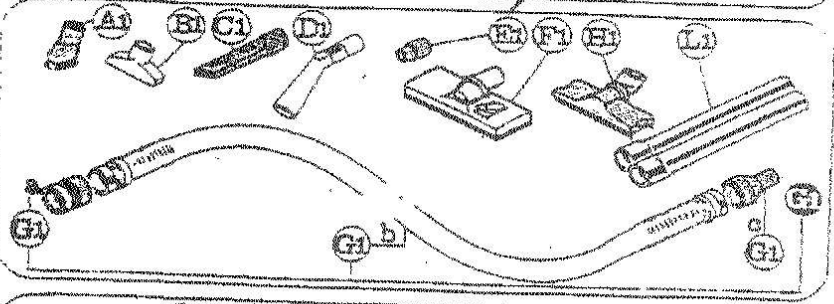
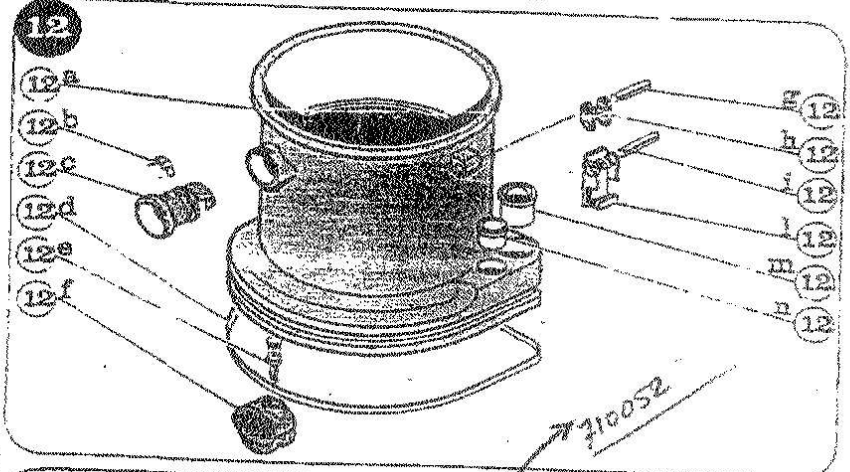
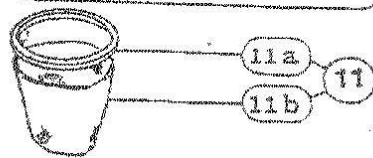
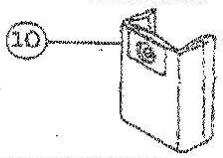
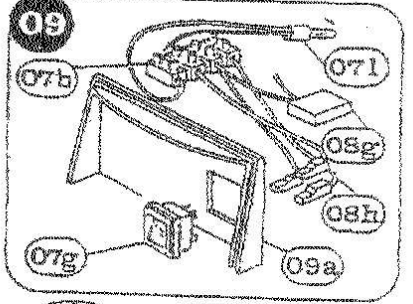
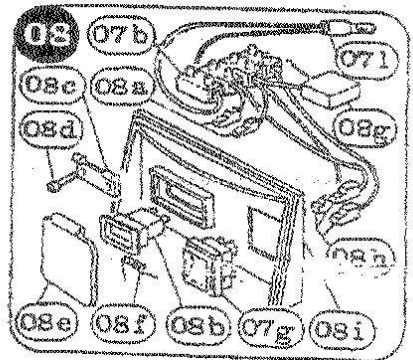
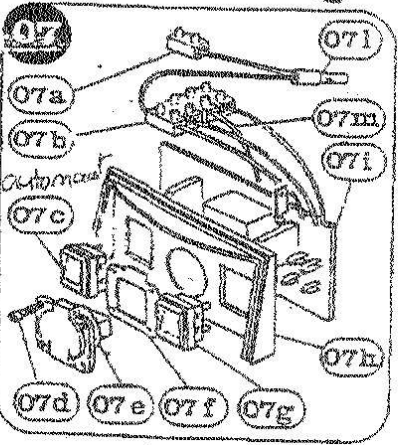
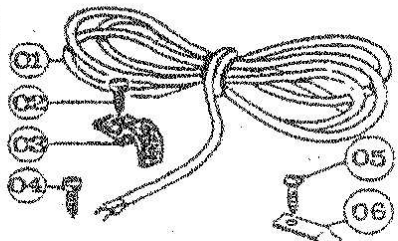

925094

electrodomestic

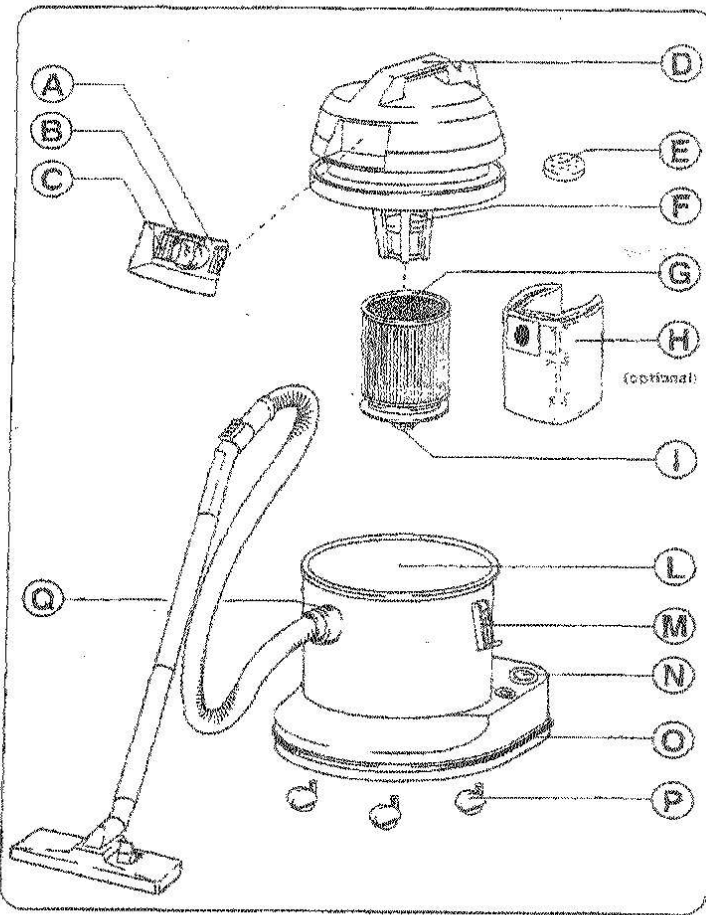

COMPONENT PARTS / ACCESSORIES

- A Switch ON-OFF (1-0)
- B Socket for electr. accessories; max. 2000 W safe load
- C Switch AUTOMATIC:
- Position M: vacuum cleaner running
- Position A: vacuum cleaner automatically starts when the accessories attached to plug B are activated.
- D Carrying handle.
- E Motor filter.
- F Float valve flap.
- G Filter cartridge.
- H Paper-dustbag. (optional)
- I Fixing button for filter cartridge.
- L Receptacle.
- M Locking device for engine bonnet.
- N Slip-on device for accessories.
- O Shock absorber.
- P Castor wheels.
- Q Fixing button for the tube.

ACCESSORY SERIES 36 mm Ø

- 1 Tube (thin).
- 2 Extension pieces.
- 3 Combination attachment for floors and carpets.
- 4 Attachment for fluids.
- 5 Brush for delicate surfaces: furniture, frames, etc.
- 6 Crevice nozzle.
- 7 Upholstery attachment.
- 8 Hand grip with air control.
- 9 Connector for electrical appliances.

ACCESSORY SERIES 58 mm Ø (OPTIONAL)

- 11 Tube (thick).
- 12 Extension pieces.
- 13 Rough dirt attachment for foliage, chippings, etc.
- 14 Large crevice nozzle for chippings, etc.
- 15 Transitional piece 58-36: enables use of attachments of the Series 36.

TECHNICAL DATA

Dimensions: height	ca. 570 mm
base	ca. 400 x 400 mm
Weight (without accessories)	ca. 8 kg
Voltage	220 V/50 Hz
Power	1000 Watt
Max. suction power	ca. 180 mbar (ca. 1600 mm H ₂ O)
Air flow	ca. 46 liter/sec.
Gross volume receptacle	ca. 24 liter
Max safe load value on electr. plug B	max. 2000 W

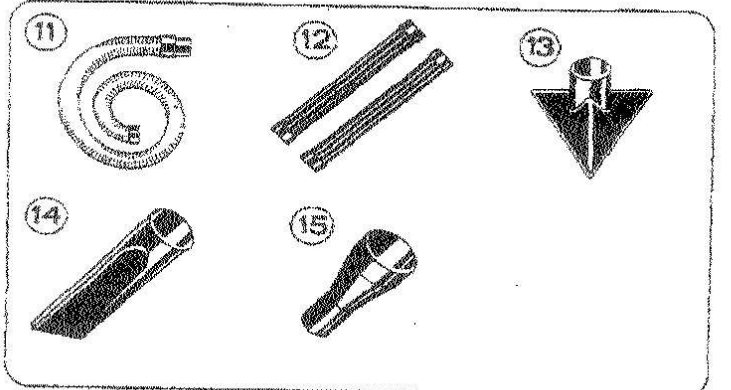
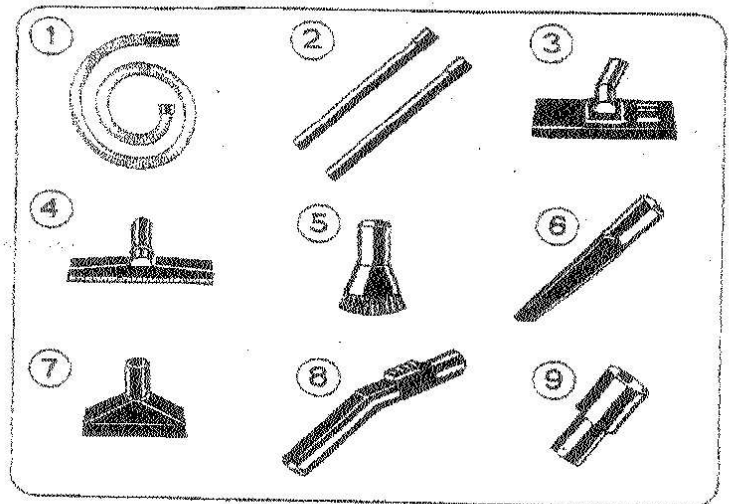

BESTANDTEILE/ZUBEHÖR

- A Schalter EIN-AUS (1-0)
- B Steckdose für elektr. Zubehör; max. 2000 W zulässig.
- C Schalter AUTOMATIC:
- Stellung M: Staubsaugerbetrieb
- Stellung A: Staubsauger springt automatisch an, wenn das an Steckdose B angeschlossene Zubehör in Betrieb gesetzt wird.
- D Traggriff.
- E Motorfilter.
- F Schwimmer-Ventilklappe.
- G Filterpatrone.
- H Papierstaubstreck. (optional)
- I Befestigungsknopf für Filterpatrone.
- L Behälter.
- M Verschlussbügel für Motorhaube.
- N Aufschiebevorrichtung für Zubehör.
- O Rammenschutz.
- P Räder, rundum drehbar.
- Q Befestigungsknopf für Schlauch.

ZUBEHÖR SERIE 36 mm Ø

- 1 Schlauch (dünn).
- 2 Verlängerungsrohre.
- 3 Kombidüse für Böden und Teppiche.
- 4 Universaldüse.
- 5 Möbel-Rundbürste.
- 6 Fugendüse.
- 7 Polsterdüse.
- 8 Handstück mit Saugkraftregulierung.
- 9 Anschlussstück für Elektrogeräte.

ZUBEHÖR SERIE 58 mm Ø (OPTIONAL)

- 11 Schlauch (dick).
- 12 Verlängerungsrohre.
- 13 Grobschmutzdüse für Laub, Späne, usw.
- 14 Gross-Fugendüse für Späne, usw.
- 15 Übergangsstück 58-36: ermöglicht Verwendung des Zubehörs Serie 36.

TECHNISCHE DATEN

Abmessungen: Höhe	ca. 570 mm
Sockel	ca. 400 x 400 mm
Gewicht (ohne Zubehör)	ca. 8 kg
Spannung	220V/50 Hz
Leistung	1000 Watt
Max. Saugleistung	ca. 180 mbar (ca. 1600 mm H ₂ O)
Luftförderung	ca. 46 Liter/Sek.
Bruttinhalt Behälter	ca. 24 Liter
max. zulässiger Anschlusswert an elektr. Steckdose B	max. 2000W

PARTS

POS	CODE NR.	OMSCHRIJVING
01	710002	SNOER 3 X 1,5 8 METER
02	710003	SCHROEF 4,8 X 19 DIN7981
03	710004	SNOERHOUDER
07	710005	AUTOMATISCHE SCHAKELSET
07b	710006	AANSLUITBLOK PA44/3
07c	710007	SCHAKELAAR M/A WD
07e	710008	CONTACTDOOS 2P+T
07f	710009	CONTACTDOOSPAKKING
07g	710011	SCHAKELAAR
07h	710012	CONTACTDOOSHOUDER
07i	710070	PRINTPLAAT
07m	710013	INTERNE DRAAD
10	710014	PAPIEREN STOFZUIGERZAK (1 STUK)
11	710015	FIJNSTOFFILTERZAK (TEXTIEL)
	710086	FIJNSTOFFILTERZAK (NYLON)
12	710016	BEHUIZING COMPLEET WDE1000
12b	710018	ONTGREDELINGSKNOP
12c	710019	SLANGAANSLUITSTUK
12d	710020	GRIJZE BUMPER
12e+f	710022	ZWENKWIEL + WIELPEN
12g	710023	SCHARNIERPEN
12h	710024	SCHARNIERPENHOUDER
12i	710025	SCHARNIERPEN
12j	710026	VASTZETKLEM
12m	710027	HULPSTUKHOUDER D.58
12n	710028	HULPSTUKHOUDER D.36
13	710029	HANDGREEPDEKSEL
14	710030	GELUIDSISOLATIE (3 STUKS)
16	710031	AFDICHTINGSPAKKING
17	710032	SCHROEF 3,5 X 19 DIN7981
18	710033	LUCHTVERDEELKAP
19	710034A	OVERBRUGGINGSRING WDE1200
20	710035	MOTORAFDICHTRING
21	710036	MOTOR 220 VOLT WDE

PARTS

POS	CODE NR.	OMSCHRIJVING
22	710037A	KOOLBORSTEL WDE1200 (1 STUK)
23	710038	AFSTANDHOUDER
24	710039	MOTORISOLATIE
25	710040	MOTORHUIS
27	710041	MOTORFILTER
28	710042	AFDICHTINGSRING
29	710043	VLOTTER
30	710044	VLOTTERHOUDER
31	710045	SCHROEF 3,5 X 16 DIN 7983
33	710046	FILTERSTEUN (ZWART)
34	710047	FILTERVASTZETKNOP
A1	710048	RONDE MEUBELBORSTEL
B1	710049	KLEINE ZUIGMOND D.36 MM
B3	710067	ZUIGMOND VOOR BLADEREN D.58 MM
C1	710050	SPLEETZUIGMOND D.36MM
C3	710066	SPLEETZUIGMOND D.58 MM
D1	710051	HANDGREEP MET LUCHTREGELING
E1	710052	VERLOOPSTUK 36/32/25 MM
E3	710068	VERLOOPSTUK 58/36 MM
F1	710053	VLOERZUIGMOND (BREED)
G1	710054	STOFZUIGERSLANG KOMPLEET D.36
G2	710085	SLANG KOMPLEET 5M D.36
G1a	710055	KOPPELSTUK (STOFZUIGERKANT)
G1b	710056	STOFZUIGERSLANG D.36 MM 1,70M
G1c	710057	KOPPELSTUK (ZUIGBUISKANT)
G3	710064	STOFZUIGERSLANG D.58 1.50M KOMPL.
H1	710058	ZUIGMOND VOOR VLOEISTOFFEN
H2	710069	RUBBER STRIP V. WATERZUIGMOND 1ST
L1	710059	ZUIGBUIS D.36MM (1 STUK)
L3	710065	ZUIGBUIS D.58MM (1 STUK)
M1	710060	HARMONICA FILTER 15 MICRON
	710088	HEPA HARMONICA FILTER 0,3 MICRON
	710083	SLANG-KOPPELSTUK KLEMRING
	710084	ELASTIEK VOOR PRINTPLAAT